

# Product Presentation at the Point of Sale

2018



## KNIPEX ErgoStrip® counter display

10 parts

00  
19

- > With 10 KNIPEX ErgoStrip® in blister pack
- > Display made of high-quality cardboard
- > Small size, minimum space required at the point of sales



Article No.	EAN 4003773-	Description	Width mm	Height mm	Depth mm	Quantity
<b>00 19 10 V01</b>	080961	KNIPEX ErgoStrip®, Universal Dismantling Tool	225	360	260	10

## KNIPEX TwinKey® counter display

10 parts

00  
19

- > Filled with 10 KNIPEX TwinKey®, the multifunctional control cabinet key
- > Display of high-quality cardboard with high gloss print



Article No.	EAN 4003773-	Description	Width mm	Height mm	Depth mm	Quantity
<b>00 19 11 V01</b>	074854	KNIPEX TwinKey®, for all standard cabinets and shut-off systems	320	380	305	10

## Universal counter display empty

00  
19

- > For 8 KNIPEX pliers up to 200 mm in length, model 02 / 05 / 06
- > Display of high-quality cardboard with high gloss print
- > Delivered empty and folded
- > Display available on purchase of 8 pliers

Article No.	EAN 4003773-	Width mm	Height mm	Depth mm
<b>00 19 12 LE04</b>	081999	170	200	400



## Overview current counter displays

Article No.	Description	Content
<b>00 19 10 V01</b>	Counter Display ErgoStrip®	10x 16 95 01 SB
<b>00 19 11 V01</b>	Counter Display TwinKey®	10x 01.11.2000
<b>00 19 11 S01</b>		
<b>00 19 12 LE04</b>	Counter Display Universal	assortment of 8 pliers on request
<b>00 19 12 V15</b>	Counter Display Needle-Nose Combination Pliers	8x 08 22 145 EAN
<b>00 19 12 V16</b>		8x 08 25 145 EAN
<b>00 19 12 V17</b>		8x 08 26 145 EAN
<b>00 19 12 V18</b>	Counter Display Dismantling Pliers	8x 13 45 165 EAN
<b>00 19 12 V19</b>		8x 13 46 165 EAN
<b>00 19 12 V20</b>	Counter Display Diagonal Cutter	8x 70 02 160 EAN
<b>00 19 12 V21</b>		8x 70 05 160 EAN
<b>00 19 12 V22</b>		8x 70 06 160 EAN
<b>00 19 12 V23</b>	Counter Display KNIPEX StriX®	8x 13 66 180
<b>00 19 19 V01</b>	Counter Display End Cutting Nipper	10x 68 01 200 EAN
<b>00 19 19 V02</b>	Counter Display Cobra®	10x 87 01 250 EAN
<b>00 19 19 V04</b>	Counter Display Alligator®	10x 88 01 250 EAN
<b>00 19 19 V09</b>	Combi Counter Display Cobra®	5x 87 01 180 EAN / 5x 87 01 250 EAN
<b>00 19 19 V10</b>		5x 87 01 250 EAN / 5x 87 01 300 EAN

Article No.	Description	Content
<b>00 19 19 V10</b>	Combi Counter Display Alligator®	5x 88 01 250 EAN / 5x 88 01 300 EAN
<b>00 19 19 V13</b>	Counter Display CoBolt®	10x 71 01 200 EAN
<b>00 19 19 V15</b>	Counter Display Alligator®	10x 88 01 300 EAN
<b>00 19 19 V16</b>	Counter Display Cobra®	10x 87 01 180 EAN
<b>00 19 19 V17</b>		10x 87 01 300 EAN
<b>00 19 19 V18</b>	Counter Display Concreters' Nippers	10x 99 00 220 EAN
<b>00 19 19 V19</b>		10x 99 00 250 EAN
<b>00 19 19 V20</b>		10x 99 00 280 EAN
<b>00 19 19 V21</b>	Counter Display High Leverage Concreters' Nippers	10x 99 14 250 EAN
<b>00 19 19 V22</b>	Combi Counter Display Alligator®	5x 88 01 180 EAN / 5x 88 01 250 EAN
<b>00 19 19 V25</b>	Counter Display Cobra® QuickSet	10x 87 21 250 EAN
<b>00 19 19 V28</b>	Combi Counter Display Concreters' Nippers	5x 99 00 220 EAN / 5x 99 00 250 EAN

## Outlook display relaunch 2018

New design – standardized display

- > First glance at our new standardized displays
- > Displays will updated successively
- > Update to exact contents will be provided



**Tray:** 180 x 200 x 70 mm (W x D x H)  
**Height:** incl. back panel 350 mm  
**Contains:** 10 products with various handles



**Tray:** 250 x 305 x 60 mm (W x D x H)  
**Height:** incl. back panel 350 mm  
**Contains:** 10 products in blister pack



Tray: 180 x 200 x 70 mm (W x D x H)  
 Height: incl. back panel 350 mm  
 Contains: 5x 99 00 220 / 5x 99 00 250



Tray: 250 x 305 x 60 mm (W x D x H)  
 Height: incl. back panel 350 mm  
 Contains: 8x 16 95 01 SB / 2x 16 95 02 SB



## Sales display for wall or counter presentation

00  
19

- > For 3 x 6 pliers
- > Filled as required
- > Suitable for attachment to tool bars or as counter display
- > Item is supplied without contents
- > Sheet steel / wire, powder coated, black



**00 19 34 4**  
For pliers finish 2; 5 or 6



**00 19 34 3**  
For pliers finish 0; 1; 3 or 4

Article No.	EAN	Width mm	Height mm	Depth mm	Quantity
<b>00 19 34 3</b>	054450	240	320	310	18
<b>00 19 34 4</b>	054467	240	320	310	18

Article No.	EAN	Content
<b>C320 00264</b>	4003773054474	Header High Leverage Pliers
<b>C320 00275</b>	4003773054535	Header Precision Circlip Pliers 48 / 49
<b>C320 00286</b>	4003773054504	Header Concreters' Nippers
<b>C320 00297</b>	4003773054481	Header KNIPEX Cobra®; Pliers Wrenches
<b>C320 00308</b>	4003773054528	Header VDE insulated pliers
<b>C320 00319</b>	4003773054498	Header Stripping, Crimping
<b>C320 00330</b>	4003773054511	Header General Programme
<b>C320 00352</b>	4003773060284	Header Multiple Slip Joint Spanners
<b>C320 00363</b>	4003773060291	Header Self-adjusting Insulation Strippers
<b>C320 00429</b>	4003773062271	Header for 74 12
<b>C320 00451</b>	4003773063032	Header KNIPEX Cobra® ES
<b>C320 00462</b>	4003773063049	Header SmartGrip®
<b>C320 00517</b>	4003773065869	Header Lineman's Pliers
<b>C320 00528</b>	4003773065876	Header Insulated Pliers Wrenches
<b>C320 00572</b>	4003773072072	Header KNIPEX CoBolt®
<b>C320 00605</b>	4003773070214	Header KNIPEX Alligator®



## Rotary sales stand

empty

- > Attractive, compact rotary construction for the counter
- > Individual, variable display for KNIPEX Tethered Tools pliers and protection system sets as well as screwdrivers
- > Material: sheet steel, powder-coated, black

### L150 01067 Attachment:

- > New attachment for 00 19 28 LE rotary stand
- > Can be equipped on both sides:
  - 1st side with "KNIPEX Tethered Tools" magnetic labels
  - 2nd side includes mounted flat magnets (ø 36 mm) for pliers up to 250 mm and loop hooks for Tethered Tools flyers
- > Material: sheet steel, powder-coated, black



Article No.	Description	Width mm	Height mm	Depth mm
00 19 28 LE	Display empty	400	490	400
L150 01067	Attachment for display	220	230	20
L130 01496 EN	KNIPEX Tethered Tools magnetic labels	220	220	2
L100 04087 EN	KNIPEX Tethered Tools flyer (with standard euro slot)	148	210	2

## Electronics pliers display empty

00  
19

- > Suitable for 24 precision electronic pliers 34 / 79
- > Stable metal body with interchangeable foam insert
- > Stable design; can be fixed on tool bar systems, also suitable as counter display
- > Including top sign and scanner label
- > Display available on purchase of 24 precision electronics pliers
- > Item is supplied without contents
- > Sheet steel, powder-coated, black



00 19 34 2 V02



00 19 34 2 V01

Article No.	EAN 4003773-	Width mm	Height mm	Depth mm	Quantity
00 19 34 2 V01	077015	410	240	190	24
00 19 34 2 V02	077022	410	240	190	24

## KNIPEX Cobra® range in sales display

00  
19

- > Display equipped with KNIPEX Cobra® water pump pliers
- > Solid style; can be fixed on tool bar systems, also suitable as counter display
- > Dimensions (W x H x D): 610 x 380 x 260 mm
- > Sheet steel / wire, powder coated, black



Article No.	EAN 4003773-	Content	Quantity
00 19 29	052340	87 01 125, 87 01 150, 87 01 180, 87 01 250, 87 01 300, 87 01 400, 87 01 560 KNIPEX Cobra®, Hightech Water Pump Pliers	3 of each

## Alligator® range in sales display

00  
19

- > Display filled with KNIPEX Alligator water pump pliers
- > Solid style; can be fixed on tool bar systems, also suitable as counter display
- > Dimensions (W x H x D): 410 x 340 x 145 mm
- > Steel wire, powder coated, silver



Article No.	EAN	Content	Quantity
00 19 29 V02	4003773-076988	88 01 180, 88 01 250, 88 01 300 KNIPEX Alligator®, Water Pump Pliers, 88 01 400 KNIPEX Alligator® XL, Pipe Wrench and Water Pump Pliers	3 of each

## Sales display for pipe wrenches empty

00  
19

- > Attractive sales display for the presentation of pipe wrenches
- > Stable design; can be fixed on tool bar systems, also suitable as counter display
- > With scanner strip to accommodate specific product labels
- > Item is supplied without contents
- > Capacity: each for 3 pipe wrenches 1", 1 1/2" and 2"
- > Dimensions (L x H x W): 645 x 370 x 170 mm
- > Sheet steel / wire, powder coated, silver



Article No.	EAN	Width mm	Height mm	Depth mm	Quantity
00 19 37	4003773-024699	645	370	170	9

## Sales display for pliers wrenches

empty

00  
19

- > Attractive sales display for presentation of pliers wrenches
- > Stable design; can be fixed on tool bar systems, also suitable as counter display
- > With scanner strip to accommodate specific product labels
- > Without pliers
- > Maximum capacity each 3 x 86 03 400 / 300 / 250 and each 5 x 86 03 180 / 150 / 125 (alternative 2 x 86 05 250 / 3 x 86 05 180 / 4 x 86 05 150)
- > Sheet steel, powder-coated, black

Article No.	EAN	Width mm	Height mm	Depth mm
<b>00 19 23 V01</b>	4003773-077732	480	390	280



## Floor display

for the presentation of bolt and mesh cutters  
empty

00  
19

- > Individually filled with up to 6 bolt and mesh cutters
- > Item is supplied without contents
- > Weight: approx. 8 kg
- > Display available on purchase of 6 bolt or mesh cutters
- > Tough metal display, powder-coated

Article No.	EAN	Width mm	Height mm	Depth mm
<b>00 19 37 1</b>	4003773-069775	300	150	490



## 00 19 20

- > For testing the self-locking function of the KNIPEX Alligator® and KNIPEX Cobra® Water Pump Pliers
- > Steady stand, high stability
- > Without pliers

## 00 19 20 S1

- > With KNIPEX Cobra® 87 01 250 on chain

## 00 19 20 T

- > For testing the self-locking function of the KNIPEX Alligator® and KNIPEX Cobra® Water Pump Pliers
- > Collapsible for space saving transport
- > Without pliers

## 00 19 21 S1

- > With pliers wrenches 86 03 250 on chain

## 00 19 21 T

- > For testing the ratchet principle of Pliers Wrenches and Multiple Slip Joint Spanner
- > Can be fixed on the wall
- > Without pliers



00 19 20



00 19 20 S1



00 19 20 T



00 19 21 S1

Article No.	EAN 4003773-	Width mm	Height mm	Depth mm
00 19 20	024637	230	165	310
00 19 20 S1	028949	230	165	310
00 19 20 T	031192	140	225	135
00 19 21 S1	039525	85	85	150
00 19 21 T	027461	30	170	30



00 19 21 T

# Demonstration kit for water pump pliers

- > For Cobra Pliers family incl. Raptor Pliers, SmartGrip® and plier wrench
- > Without pliers

Article No.	EAN 4003773-	Width mm	Height mm	Depth mm
00 40 04	069348	30	170	30



## Demonstration kit for circlip pliers

00  
40

- > For circlip pliers (inside and outside)
- > For demonstrating assembly and disassembly
- > With circlip pliers in different sizes
- > Without pliers



Article No.	EAN 4003773-	Width mm	Height mm	Depth mm
00 40 01	050735	68,5	33,5	68,5

## Tool bar with illuminated fascia panel

00  
19

- > To be individually filled on site

### 00 19 30

- > For the promotional, extensive product presentation
- > Completely with supports, 5 peg boards, shelf and illuminated transparent advertising fascia panel
- > Can be equipped either with pliers on hooks, carded pliers and / or sales displays
- > With power cable and 230 V plug
- > Material: sheet steel / steel tubing, silver powder coated

### 00 19 30 3

- > For the promotional, extensive product presentation
- > Completely with supports, 5 peg boards, shelf; without illuminated transparent advertising fascia panel
- > Can be equipped either with pliers on hooks, carded pliers and / or sales displays
- > Material: sheet steel / steel tubing, silver powder coated

### 00 19 30 66

- > For the space saving presentation
- > Completely with supports, 5 peg boards, shelf; without illuminated transparent advertising fascia panel
- > With magnetic advertising fascia panel
- > Can be equipped either with pliers on hooks, carded pliers and / or sales displays
- > Material: sheet steel / steel tubing, silver powder coated



00 19 30

Article No.	EAN 4003773-	Description	Width mm	Height mm	Depth mm
00 19 30	024644	Tool Bar with illuminated fascia panel	1000	2200	500
00 19 30 3	052524	Tool Bar without illuminated fascia panel	1000	2200	500
00 19 30 66	055211	With magnetic advertising fascia panel	660	2200	500

## Illuminated fascia for tool bar

00  
19

> Illuminated fascia panel, to affix to tool bar systems



Article No.	EAN	Description	Width mm	Height mm	Depth mm
00 19 30 2	4003773-046783	KNIPEX Quality – Made in Germany	1000	200	400

## Centre gondola 2-sided empty

00  
19

- > To be individually filled on site
- > Complete with connectors, six tool bars, two shelves, without light
- > Can be equipped either with pliers on hooks, carded pliers and / or sales displays
- > Sheet steel / profile, powder-coated, silver

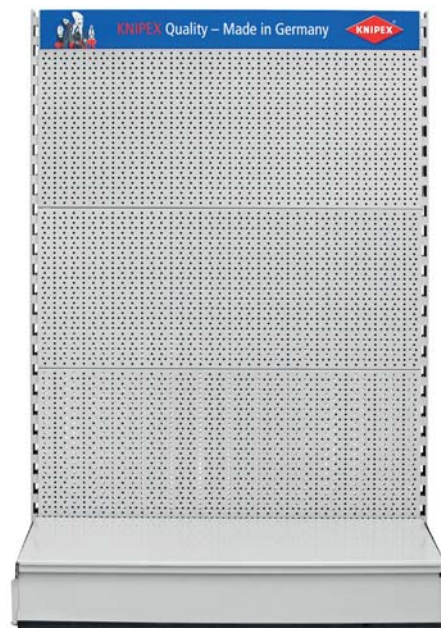

Article No.	EAN	Width mm	Height mm	Depth mm
00 19 30 V07	4003773-078166	1000	1400	930

## Gondola cover empty

00  
19

- > For water pump pliers from 300 mm to 560 mm in length
- > Suitable for centre gondolas with a width of 1000 mm
- > Dimensions (W x H x D): 1000 x 135 x 75 mm
- > Sheet steel, powder coated, silver



Article No.	EAN	Width mm	Height mm	Depth mm
00 19 30 V06	4003773-078098	1000	135	75

## Second placement empty

00  
19

- > To extend the product range
- > Two presentation areas
- > Easy and fast assembly
- > Delivered empty: please order pliers, magnetic labels and hooks separately
- > Sheet steel, powder coated, silver

### 00 19 30 V04

2-sided

### 00 19 30 V05

3-sided

Article No.	EAN 4003773-	Width mm	Height mm	Depth mm
<b>00 19 30 V04</b>	078074	390	2000	390
<b>00 19 30 V05</b>	078081	390	1850	390



00 19 30 V04



00 19 30 V05

## Show-cabinets for product presentation

for assembly to tool bar systems

00  
19

- > With two glass sliding doors, lockable
- > With transparent advertising fascia panel
- > Illumination unit with plug for series connection
- > With power cable and 230 V plug
- > High-quality aluminium / glass structure
- > Without pliers

### 00 19 30 VIT

Hanging show-cabinet for assembly on tool bar systems; with shelf, top cover and transparent advertising fascia panel; easy to assemble collapsible frame construction

### 00 19 30 VIT 1

Basic show-cabinet for assembly to tool bar systems; with top cover and transparent advertising fascia panel

### 00 19 30 VIT 3

Twin show cabinet for assembly on tool bar systems; with top cover and transparent advertising fascia panel



00 19 30 VIT 1

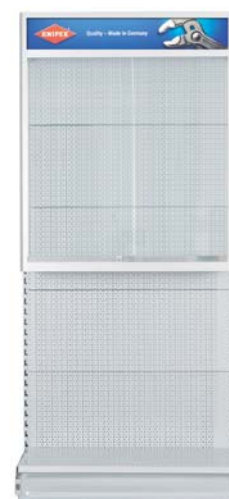

00 19 30 VIT 2



00 19 30 VIT 3

Article No.	EAN 4003773-	Description	Width mm	Height mm	Depth mm
<b>00 19 30 VIT</b>	034186	Hanging Show-Cabinet for Tool Bar	1000	1200	400
<b>00 19 30 VIT 1</b>	048978	Basic Show-Cabinet for Product Presentation	1000	2000	400
<b>00 19 30 VIT 3</b>	077589	Twin show cabinet for tool bar systems	2000	2000	400

## Product sliding wall empty

00  
19

- > For up to 18 x 3 additional products
- > Welded frame element for KNIPEX tool bars with a width of 1000 mm (Art. 00 19 30)
- > Easy and fast assembly
- > Delivered empty: please order pliers, magnetic labels and hooks separately
- > Presentation area (B x H): 250 x 1850 mm
- > Steel profile, powder coated, silver



Article No.	EAN	Width mm	Height mm	Depth mm
00 19 30 V01	4003773-078043	1000	1850	350

## Shelf stopper empty

00  
19

- > For attachment in the tool bar axis (H perforation)
- > Up to 16 x 3 products
- > Delivered empty: please order pliers, magnetic labels and hooks separately
- > Dimensions (W x H x D): 460 x 800 x 25 mm
- > Presentation area (W x H): 260 x 800 mm (2x)
- > Sheet steel, powder-coated, black

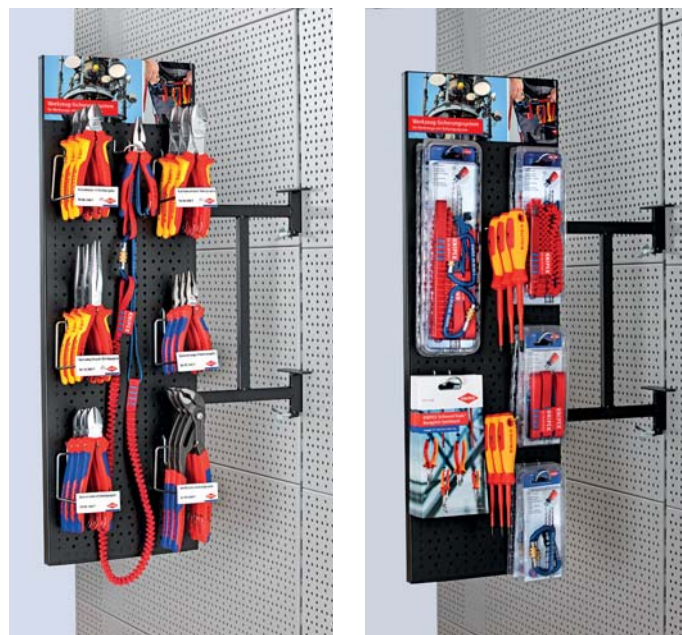

Article No.	Width mm	Height mm	Depth mm
00 19 30 V03	460	800	25

## Triangle shelf stopper

for eye-catching product presentation, empty

00  
19

- > For attachment in the tool bar axis (H perforation)
- > Up to 16 x 3 products
- > Delivered empty: please order pliers, magnetic labels and hooks separately
- > Presentation area (W x H): 165 x 800 (2x)
- > Sheet steel, powder-coated, black



Article No.	EAN	Width mm	Height mm	Depth mm
00 19 30 V02	4003773-078050	430	800	155

## Shelf bottom for tool bar

empty

00  
19

- > For attachment to tool bars
- > With 2 tool bar hooks
- > Dimensions (W x H x D): 300 x 200 x 40 mm
- > Sheet steel, powder coated, silver



Article No.	EAN	Width mm	Height mm	Depth mm
00 19 30 V08	4003773-078203	300	200	40

## Hooks for pegboard

00  
19

- > For assembly to tool bars
- > Different models and dimensions, see Table

### 00 19 31

160 mm length; For 6 pliers, with face plate for label; when ordering, do always ask for product detail labels

### 00 19 33

90 mm length; For 3 pliers, with faceplate for label; when ordering, do always ask for product detail labels

### 00 19 33 2

200 mm length; heavy duty for mounting pipe wrenches, etc.; with pivoting clamping device for easy fastening and release

### 00 19 35 1

200 mm length; for self-service packs with Euro standard perforations; with pivoting clamping device for easy fastening and release

### 00 19 35 2

50 mm length; for self-service (carded) packs and leaflets with Euro standard perforations

### 00 19 35 3

200 mm length; for self-service packs with Euro standard perforations; with pivoting clamping device for easy fastening and release

### 00 19 35 4

Hook lock for 00 19 35 1 and 00 19 35 3

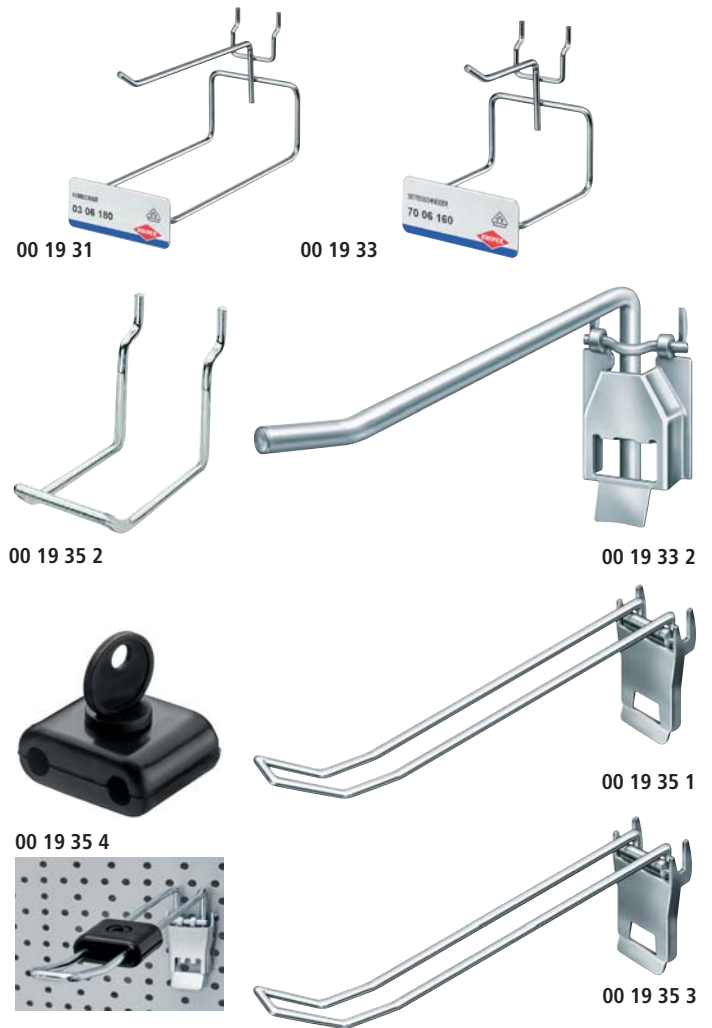

Article No.	EAN 4003773-	Description	Hole spacing mm	Depth mm
00 19 31	014874	for 6 pliers	30	160
00 19 33	014881	for 3 pliers	30	90
00 19 33 2	042112	for large size water pump pliers, pipe wrenches, etc.	30	200
00 19 35 1	045168	for self-service packs	25	200
00 19 35 2	028284	for brochures + carded tools	30	50
00 19 35 3	051787	for self-service packs	30	200

## Brochure holder for pegboards

00  
19

- > For approx. 250 pcs. A4-size leaflets
- > Delivered empty; please order brochures separately
- > Steel wire, powder coated, silver

Article No.	EAN 4003773-	Width mm	Height mm	Depth mm
00 19 36	024682	230	290	90



- > For presentation of up to 15 self-service packs
- > Please order pliers separately
- > Suitable product label available on request
- > Plastic, opaque



L130 01496  
KNIPEX  
Tethered  
Tools  
magnetic  
labels



View side 2



View sides 3 and 4

Wall attachment for perforated  
tool bar system and magnetic label

- > For the presentation of KNIPEX Tethered Tools
- > Can be used with or without magnetic label



Article No.	Description	EAN
00 19 30 V09	Red wall attachment	4003773-082255
Magnetic labels		Dimensions
L130 01507	The tool protection system	German
L130 01507 EN		English
L130 01507 ES		Spanish
L130 01507 FR		French
L130 01507 IT		Italian
L130 01507 CZ		Czech
L130 01507 PL		Polish

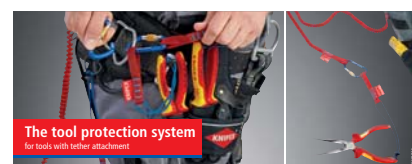

## Magnetic labels

Article No.	Description		Dimensions
L130 01144	Dismantling Pliers	German	125 x 100 mm
L130 01144 EN		English	
L130 01144 ES		Spanish	
L130 01144 FR		French	
L130 01144 IT		Italian	
L130 01155	KNIPEX ErgoStrip®		125 x 100 mm
L130 01166	Tile Breaking Pliers	German	125 x 100 mm
L130 01166 EN		English	
L130 01166 ES		Spanish	
L130 01166 FR		French	
L130 01166 IT		Italian	
L130 01177	Precision Electronics Gripping Pliers	German	125 x 100 mm
L130 01177 EN		English	
L130 01177 ES		Spanish	
L130 01177 FR		French	
L130 01177 IT		Italian	
L130 01188	Needle-Nose Combination Pliers	German	125 x 100 mm
L130 01188 EN		English	
L130 01188 ES		Spanish	
L130 01188 FR		French	
L130 01188 IT		Italian	
L130 01199	KNIPEX Cobra® XL		125 x 100 mm
L130 01210	Spring Hose Clamp Pliers	German	125 x 100 mm
L130 01210 EN		English	
L130 01210 ES		Spanish	
L130 01210 FR		French	
L130 01210 IT		Italian	
L130 01221	Long Reach Needle Nose Pliers	German	125 x 100 mm
L130 01221 EN		English	
L130 01221 ES		Spanish	
L130 01221 FR		French	
L130 01221 IT		Italian	
L130 01232	Diagonal Cutter	German	125 x 100 mm
L130 01232 EN		English	
L130 01232 ES		Spanish	
L130 01232 FR		French	
L130 01232 IT		Italian	
L130 01243	KNIPEX X-Cut®		125 x 100 mm
L130 01540	Pliers Wrench	German	125 x 100 mm
L130 01540 EN		English	
L130 01540 ES		Spanish	
L130 01540 FR		French	
L130 01540 IT		Italian	
L130 01287	Siphon- and Connector Pliers	German	125 x 100 mm
L130 01287 EN		English	
L130 01287 ES		Spanish	
L130 01287 FR		French	
L130 01287 IT		Italian	

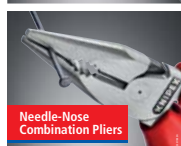
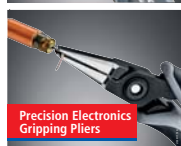
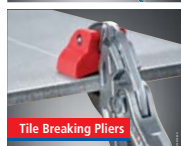
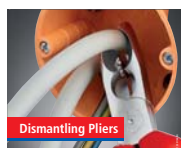

Article No.	Description		Dimensions	
L130 01408	Electronic Super Knips®		125 x 100 mm	
L130 01430	High Leverage Flush Cutter	German	125 x 100 mm	
L130 01430 EN		English		
L130 01430 ES		Spanish		
L130 01430 FR		French		
L130 01430 IT		Italian		
L130 01441	Hose Clamp Pliers for Click clamps	German	125 x 100 mm	
L130 01441 EN		English		
L130 01441 ES		Spanish		
L130 01441 FR		French		
L130 01441 IT		Italian		
L130 01452	KNIPEX StriX		125 x 100 mm	
L130 01463	KNIPEX StriX VDE		125 x 100 mm	
L130 01474	ACSR Cable Cutter	German	125 x 100 mm	
L130 01474 EN		English		
L130 01474 ES		Spanish		
L130 01474 FR		French		
L130 01474 IT		Italian		
L130 01485	Pliers Wrench 12°	German	125 x 100 mm	
L130 01485 EN		English		
L130 01485 ES		Spanish		
L130 01485 FR		French		
L130 01485 IT		Italian		
L130 01265	KNIPEX Cobra® Quick Set		125 x 100 mm	
L130 01628	KNIPEX TwinForce®		125 x 100 mm	
L130 01562	Pliers for Electrical Installation	German	125 x 100 mm	
L130 01562 EN		English		
L130 01562 ES		Spanish		
L130 01562 FR		French		
L130 01562 IT		Italian		
L130 01573	KNIPEX CoBolt®		125 x 100 mm	
L130 01122	NEW	German	250 x 100 mm	
L130 01122 EN		English		
L130 01122 ES		Spanish		
L130 01122 FR		French		
L130 01122 IT		Italian		

# Magnetic labels

Article No.	Description		Dimensions
L130 01892	KNIPEX ErgoStrip® L		125 x 100 mm
L130 01859	KNIPEX Twistor16		125 x 100 mm
L130 01793	KNIPEX Cobolt® S		125 x 100 mm
L130 01727	KNIPEX TwistCut		125 x 100 mm
L130 01760	Wire Rope Cutter	German	125 x 100 mm
L130 01760 EN		English	
L130 01760 ES		Spanish	
L130 01760 FR		French	
L130 01826	Pliers Wrench	German	125 x 100 mm
L130 01826 EN		English	
L130 01826 ES		Spanish	
L130 01826 FR		French	
L130 01254	KNIPEX Cobra®		250 x 100 mm
L130 01265	KNIPEX ErgoStrip®		250 x 100 mm
L130 01276	Pliers Wrench	German	250 x 100 mm
L130 01276 EN		English	
L130 01276 ES		Spanish	
L130 01276 FR		French	
L130 01276 IT		Italian	
L130 01320	Circlip Pliers	German	250 x 100 mm
L130 01320 EN		English	
L130 01320 ES		Spanish	
L130 01320 FR		French	
L130 01320 IT		Italian	
L130 01342	Crimping Pliers	German	250 x 100 mm
L130 01342 EN		English	
L130 01342 ES		Spanish	
L130 01342 FR		French	
L130 01342 IT		Italian	
L130 01507	The tool protection system	German	250 x 100 mm
L130 01507 EN		English	
L130 01507 ES		Spanish	
L130 01507 FR		French	
L130 01507 IT		Italian	
L130 01507 CZ		Czech	
L130 01507 PL	Polish		

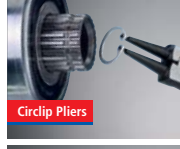
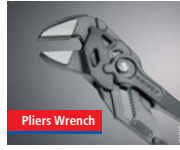

Article No.	Description		Dimensions
L130 01551	KNIPEX Electronic Super Knips® XL		250 x 100 mm
L130 01419	Spring Hose Clamp Pliers	German	250 x 100 mm
L130 01419 EN		English	
L130 01419 ES		Spanish	
L130 01419 FR		French	
L130 01419 IT		Italian	
L130 01518	KNIPEX TwinKey®		250 x 100 mm
L130 01584	KNIPEX X-Cut®		250 x 100 mm
L130 01595	KNIPEX TwinForce®		250 x 100 mm
L130 01606	Pliers for Electrical Installation	German	250 x 100 mm
L130 01606 EN		English	
L130 01606 ES		Spanish	
L130 01606 FR		French	
L130 01606 IT		Italian	
L130 01617	KNIPEX CoBolt®		250 x 100 mm
L130 01529	Needle-Nose Combination Pliers	German	250 x 100 mm
L130 01529 EN		English	
L130 01529 ES		Spanish	
L130 01529 FR		French	
L130 01529 IT		Italian	
L130 01375	NEW	German	250 x 100 mm
L130 01375 EN		English	
L130 01375 ES		Spanish	
L130 01375 FR		French	
L130 01375 IT		Italian	
L130 01903	KNIPEX ErgoStrip® L		250 x 100 mm
L130 01870	KNIPEX Twistor16		250 x 100 mm
L130 01793	KNIPEX CoBolt® S		250 x 100 mm

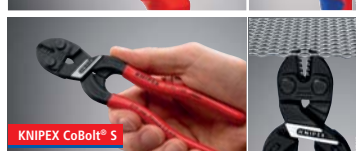
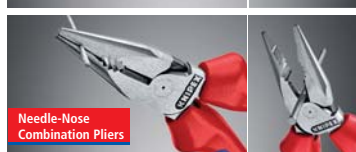
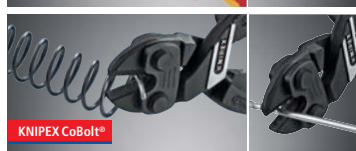
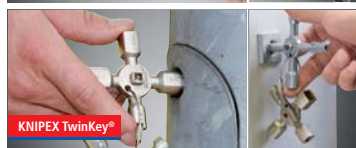
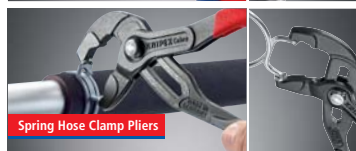

# Magnetic labels

Article No.	Description		Dimensions
L130 01738	KNIPEX TwistCut		250 x 100 mm
L130 01771	Wire Rope Cutter	German	250 x 100 mm
L130 01771 EN		English	
L130 01771 ES		Spanish	
L130 01771 FR		French	
L130 01837	Pliers Wrench	German	250 x 100 mm
L130 01837 EN		English	
L130 01837 ES		Spanish	
L130 01837 FR		French	
L130 01496	Tethered Tools	German	220 x 220 mm
L130 01496 EN		English	
L130 01496 ES		Spanish	
L130 01496 FR		French	
L130 00330	World of Diagonal Cutters	German	660 x 160 mm
L130 00330 EN		English	
L130 00330 ES		Spanish	
L130 00330 FR		French	
L130 00330 IT		Italian	
L130 00330 NL		Dutch	
L130 00330 PT		Portuguese	
L130 00330 RU	Russian		
L130 01672	KNIPEX		210 width
00 1930 15 SH-01	KNIPEX Quality – Made in Germany		900 x 100
00 1930 15-01	KNIPEX Quality – Made in Germany		980 x 100
00 1930 16 SH-01	KNIPEX Quality – Made in Germany VDE		900 x 100
00 1930 16-01	KNIPEX Quality – Made in Germany VDE		980 x 100
00 1930 17-01	KNIPEX Quality – Made in Germany		650 x 100

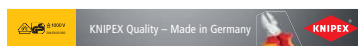
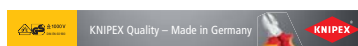
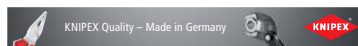
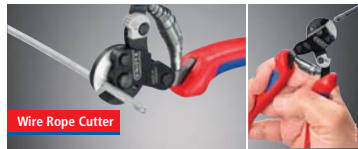

Article No.	Description		Dimensions
<b>00 1930 18-01</b>	KNIPEX Quality – Made in Germany		650 x 100
	VDE		
<b>00 1930 19SH-01</b>	KNIPEX Quality – Made in Germany		650 x 100
<b>00 1930 19-01</b>	KNIPEX Quality – Made in Germany		980 x 200
<b>00 1930 20-01</b>	KNIPEX Quality – Made in Germany		650 x 250
<b>L130 01298</b>	Cutting - Stripping - Crimping	German	988 x 100 mm
<b>L130 01298 EN</b>		English	
<b>L130 01298 ES</b>		Spanish	
<b>L130 01298 FR</b>		French	
<b>L130 01298 IT</b>		Italian	
<b>L130 01331</b>	Insulated Tools	German	988 x 100 mm
<b>L130 01331 EN</b>		English	
<b>L130 01331 ES</b>		Spanish	
<b>L130 01331 FR</b>		French	
<b>L130 01331 IT</b>		Italian	

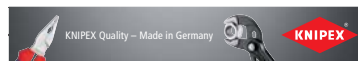
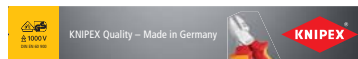

# Roll-up banner

Article No.	Description		Dimensions
L150 00539 EN	Spring Hose Clamp Pliers	English	850 x 2000 mm
L150 00550 EN	Pliers Wrench XL	English	850 x 2000 mm
L150 00649 EN	Pliers Group	English	850 x 2000 mm
L150 00704	KNIPEX ErgoStrip®	German	850 x 2000 mm
L150 00880	Pliers Wrench XL	German	850 x 2000 mm
L150 00880 FR		French	
L150 00891	Spring Hose Clamp Pliers	German	850 x 2000 mm
L150 00891 FR		French	
L150 00891 EN		English	
L150 01012 EN	KNIPEX Super Knips® XL	English	850 x 2000 mm
L150 01045 EN	ACSR Cable Cutter	English	850 x 2000 mm
L150 01056 EN	Pliers Wrench, angled shape	English	850 x 2000 mm
L150 01122	KNIPEX TwistCut®	German	850 x 2000 mm
L150 01122 EN		English	
L150 01133	Wire Rope Cutter	German	850 x 2000 mm
L150 01133 EN		English	
L150 01144	KNIPEX CoBolt® S	German	850 x 2000 mm
L150 01144 EN		English	
L150 01155	Pliers Wrench	German	850 x 2000 mm
L150 01155 EN		English	
L150 01166	KNIPEX Twistor16	German	850 x 2000 mm
L150 01166 EN		English	
L150 01177	KNIPEX ErgoStrip® L	German	850 x 2000 mm
L150 01177 EN		English	
L150 01188	Electronics Pliers	German	850 x 2000 mm
L150 01188 EN		English	
L150 01199	Welcome	German	850 x 2000 mm
L150 01199 EN		English	



Roll-up banner system

L150 01177



L150 01133



L150 01144



## Beach flags

- > Mobile flag pole "T-Pole 200"
- > Ground plate dimensions 550 x 550 mm
- > Flag size 80 x 3000 mm
- > Telescope pole can be varied in length from 2200 up to 6000 mm
- > Two flag designs available

Article No.	Description	Dimensions
<b>L150 00990</b>	KNIPEX branding flag incl. ground plate & pole	80 x max 6000 mm
<b>L150 01001</b>	KNIPEX Cobra® flag incl. ground plate & pole	80 x max 6000 mm



L150 00990



L150 01001





**KNIPEX-Werk**  
**C. Gustav Putsch KG**

42337 Wuppertal  
Germany

Tel.: +49 (0) 202 – 47 94-0  
Fax: +49 (0) 202 – 47 74 94

[info@knipex.com](mailto:info@knipex.com)  
[www.knipex.com](http://www.knipex.com)